

Elongated CUPOLA
solid base
(electrical *optional*)

GAZEBO STRUCTURAL SYSTEM
SERIES GHE- 14B MODEL
(14' x 19', DOUBLE-TIER)

Lumber:
Western Red CEDAR #1 (Cabinet)
Shingles:
5X / 16" long / 1/2" thick
or 16 oz. copper

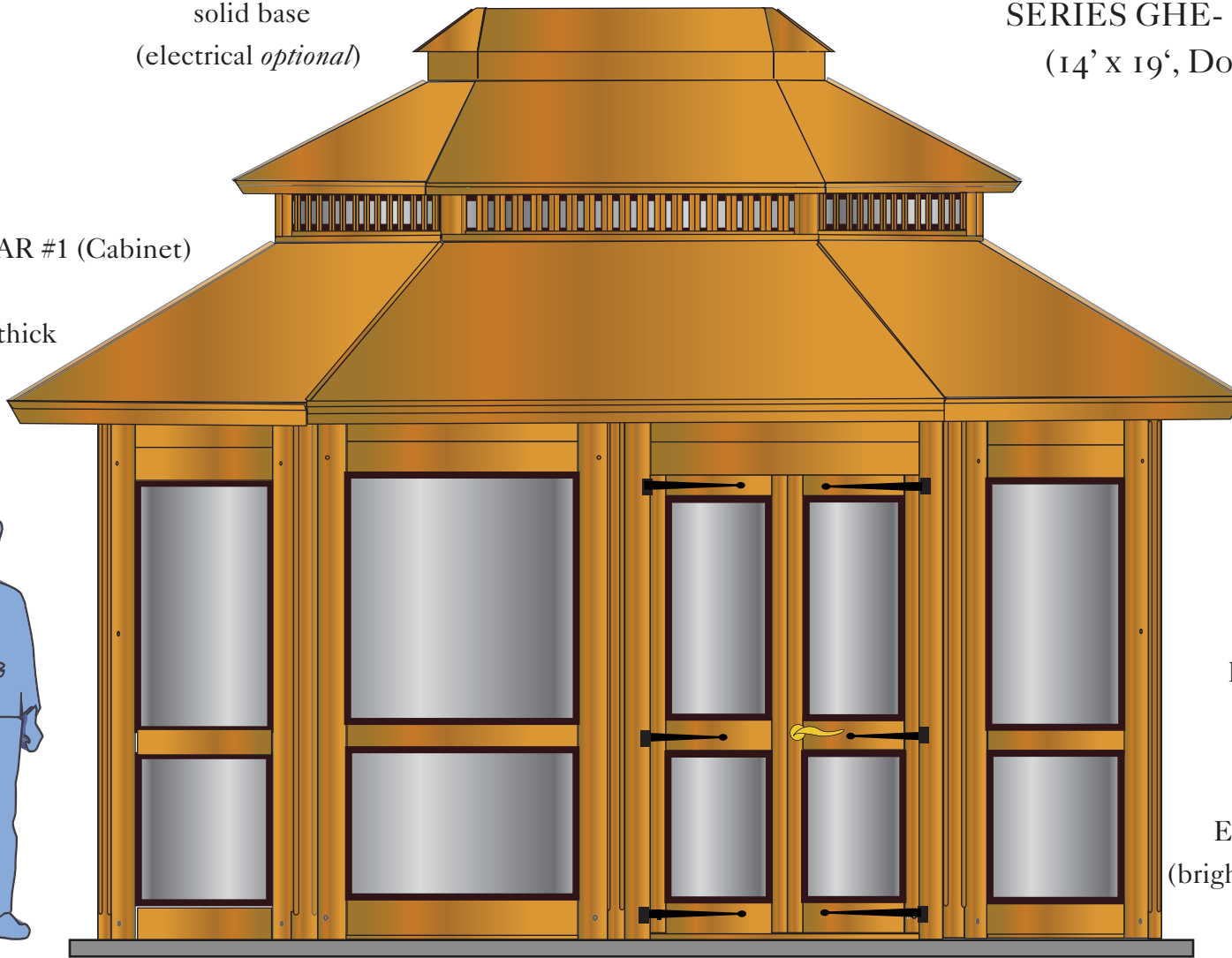
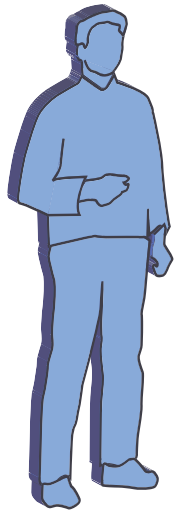

Removable Screen
Inserts
(top & bottom)

Entry Door Lock Set
(bright brass or dark bronze)



**VIXEN HILL CEDAR
PRODUCTS**

P.O.Box 389 - Elverson, PA 19520
800-423-2766

Created by: Andrea Beringer

Date: Jan 2015

Model: GHE-14B without floor

Drawing: 1 of 10

SIZE & DIMENSIONS

Key: Based on roof type	14' x 19' B
*A: Height, Overall	168"
B: Height, Grade/peak	158"
C: Height, Door Entr.	80 1/4"
D: Height, Top to Cross-Rail	34"
J: Width, Door Entr.	52"
K: Width, Interior Length	210 1/2"

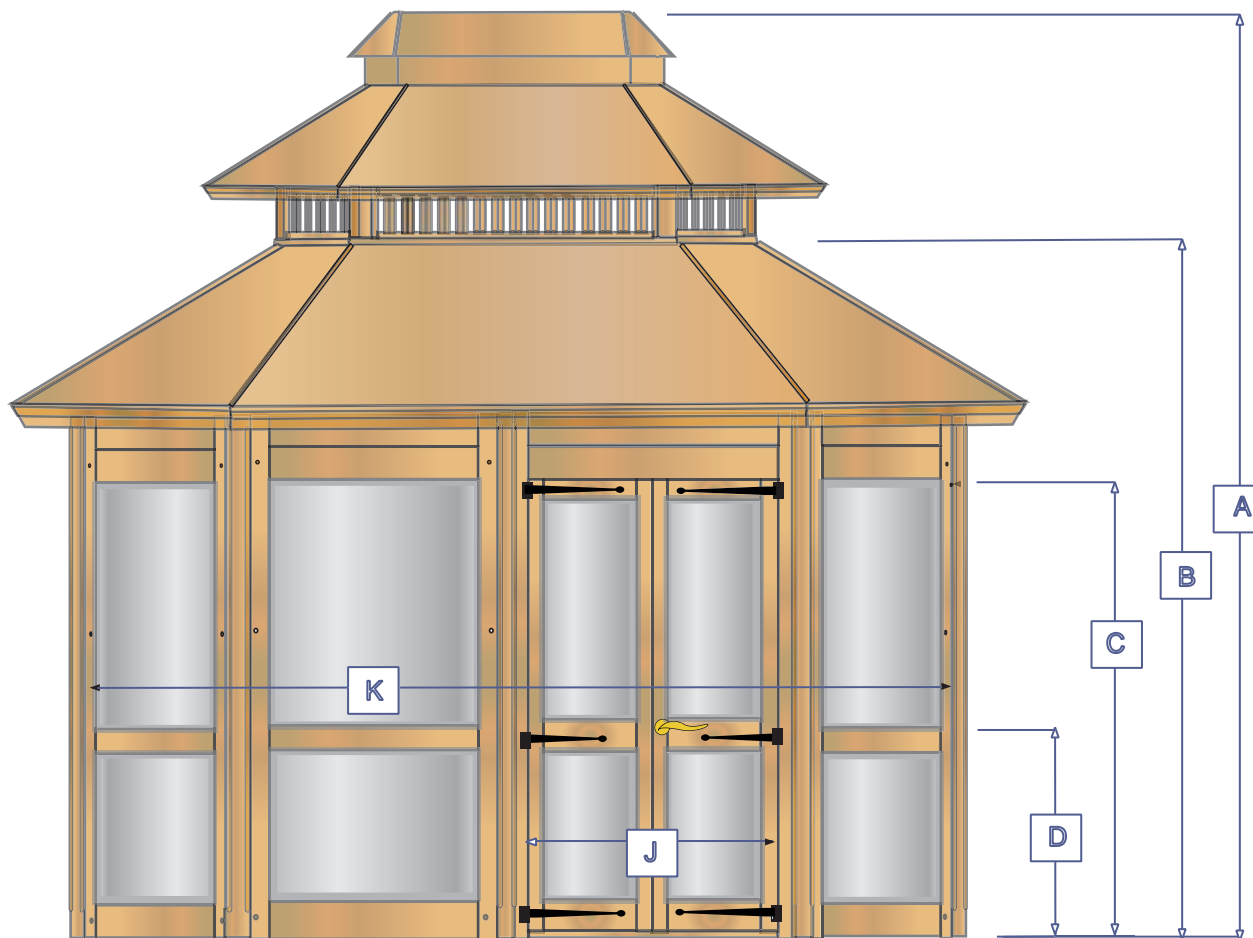

**VIXEN HILL CEDAR
PRODUCTS**

P.O.Box 389 - Elverson, PA 19520
800-423-2766

Created by: Andrea Beringer

Date: Jan 2015

Model: GHE-14B without floor

Drawing: 2 of 10

WALL PANEL CONSTRUCTION

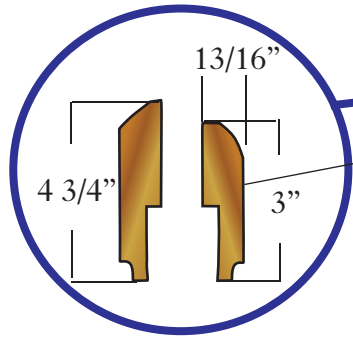

Inner Panel Cap
Outer Panel Cap



PLATED ROTO LOCK CONNECTS WALL PANEL TO POST.

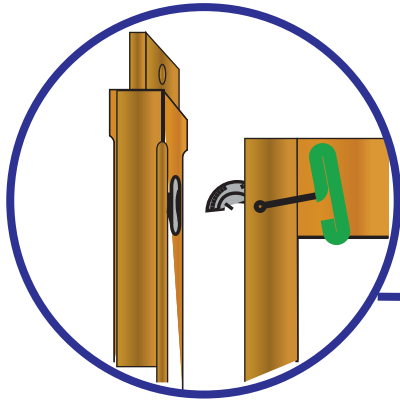

4X4 Post

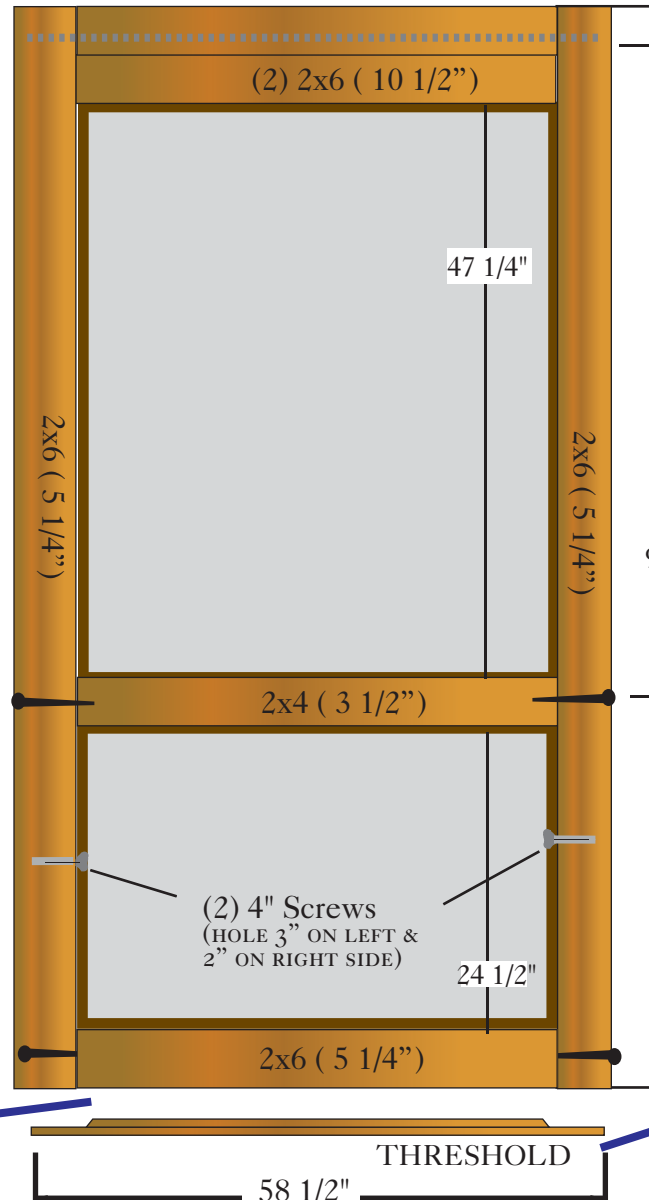

Threaded-Through-Rod

There are two (2) wall panels on each elongated side, joined by a MID POST without roto-locks.

91"

6" Structural Screws

(2) 4" Screws
(HOLE 3" ON LEFT & 2" ON RIGHT SIDE)

24 1/2"

2x6 (5 1/4")

58 1/2"

THRESHOLD

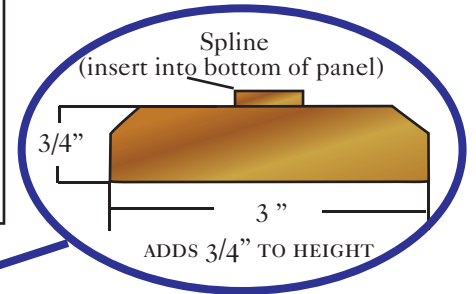

Spline
(insert into bottom of panel)

3/4"

3"

ADDS 3/4" TO HEIGHT

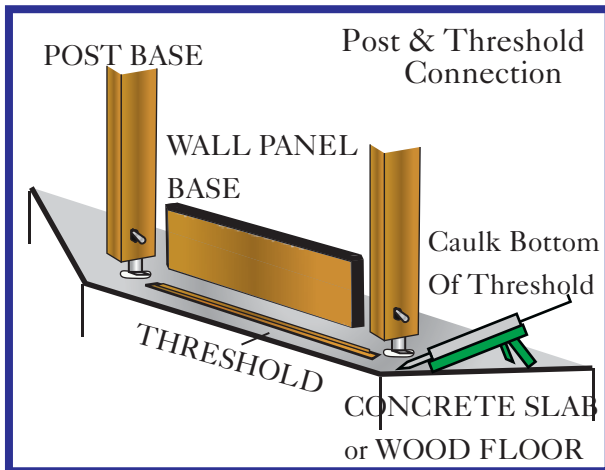

VIXEN HILL CEDAR PRODUCTS

P.O.Box 389 - Elverson, PA 19520
800-423-2766

Created by: Andrea Beringer

Date: Jan 2015

Drawing: 3 of 10

Model: GHE-14

DOUBLE DOOR CONSTRUCTION

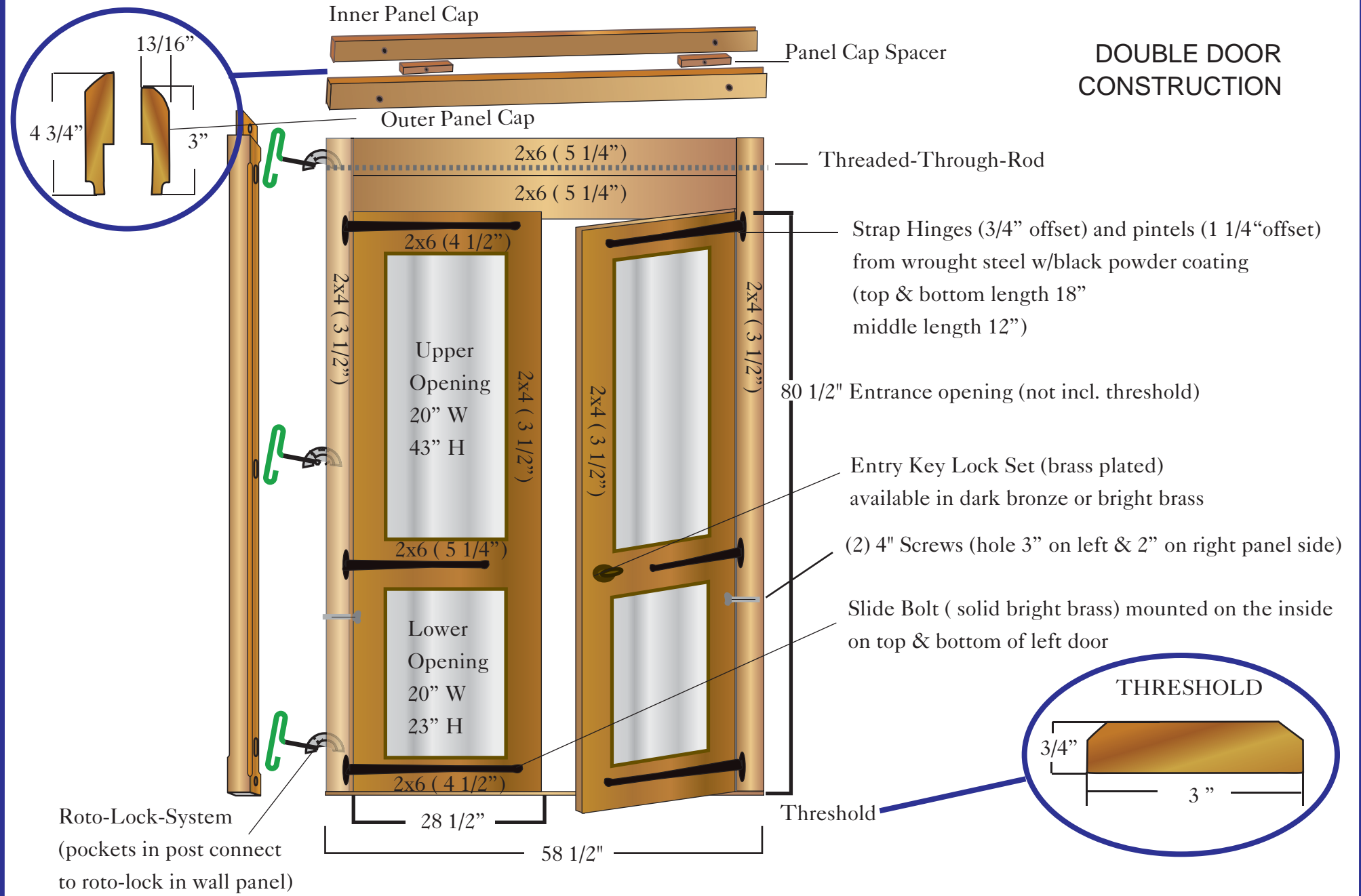

LOWER TIER ROOF CONSTRUCTION

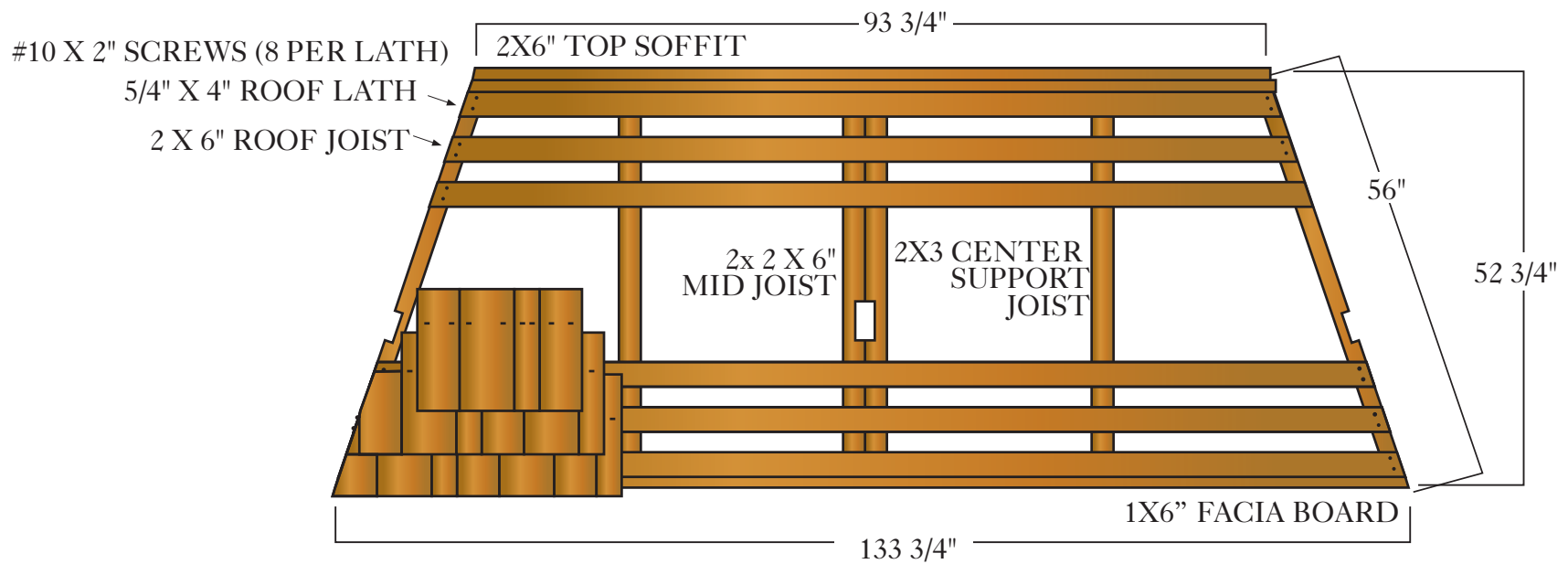
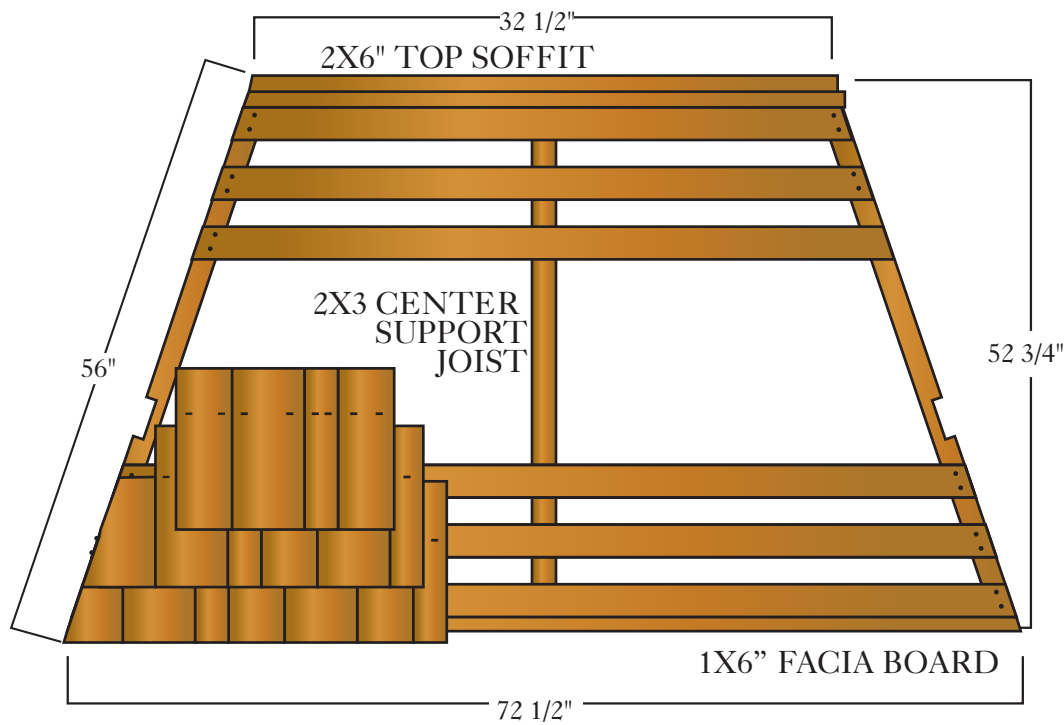

**VIXEN HILL CEDAR
PRODUCTS**

P.O.Box 389 - Elverson, PA 19520
800-423-2766

Created by: Andrea Beringer

Date: Jan 2015

Drawing: 5 of 10

Model: GHE-14B

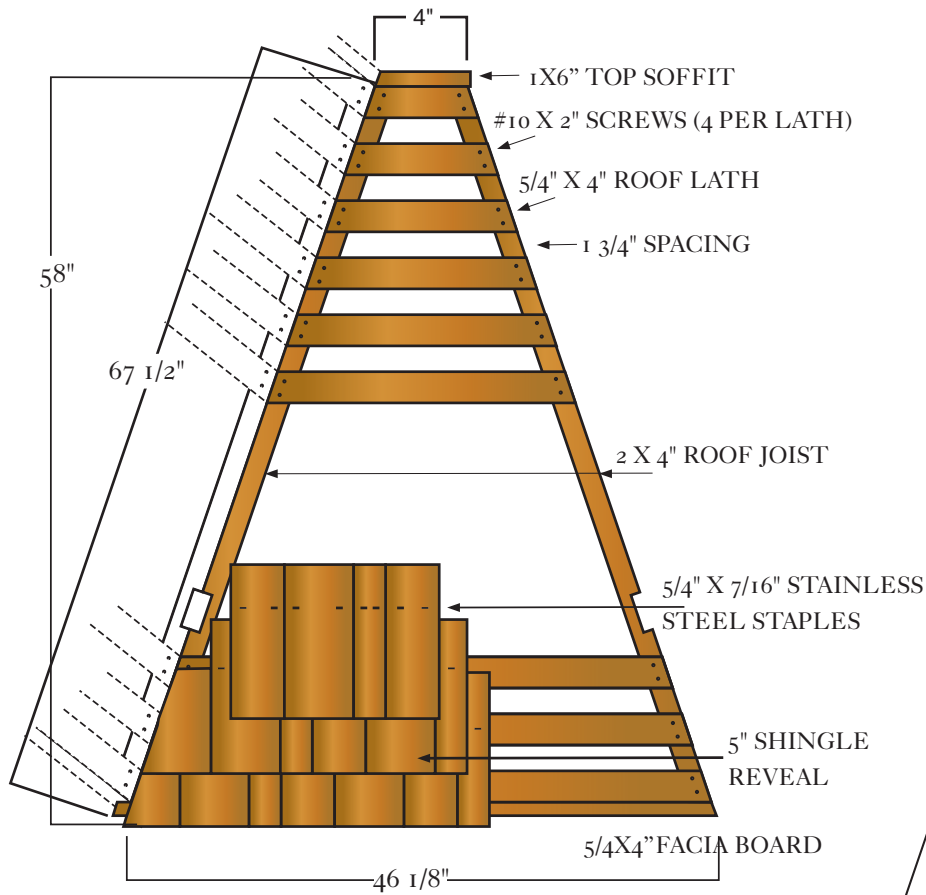

UPPER TIER ROOF CONSTRUCTION

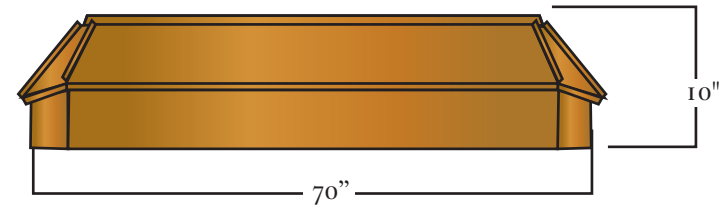

THE CUPOLA IS CONNECTED WITH STAINLESS STEEL SCREW FROM THE UNDER SIDE OF THE ROOF LATH.

CEDAR SHINGLE OR 16 OZ. COPPER

ELONGATED UPPER ROOF MODULE

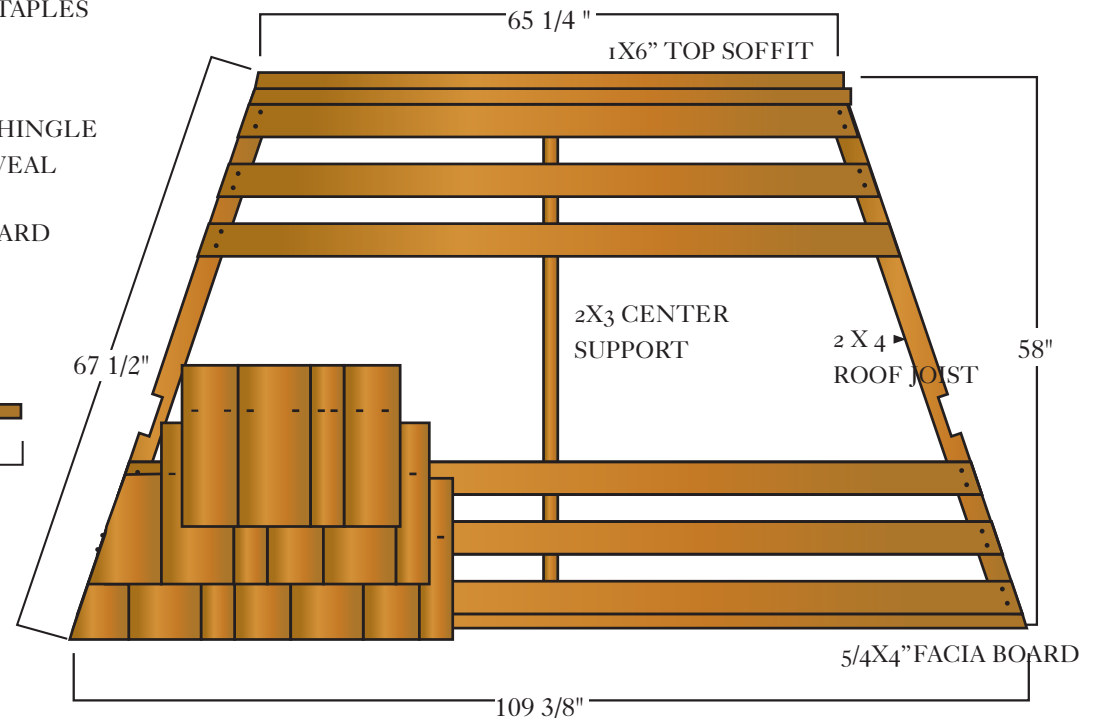

UPPER FRET

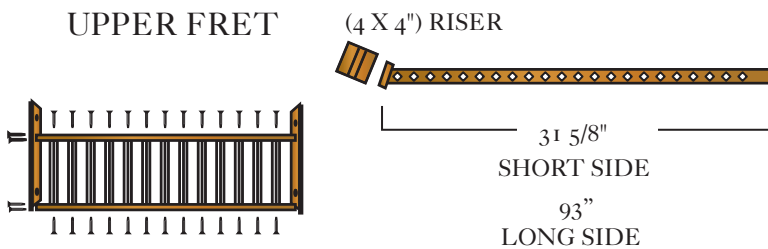

(5/4 X 5/4") SPINDLE (2 X 3") RAIL
 (5/4 X 4") FRET FRAME
 #10 X 2" SCREWS



VIXEN HILL CEDAR PRODUCTS

P.O.Box 389 - Elverson, PA 19520
 800-423-2766

Created by: Andrea Beringer

Date: Jan 2015

Drawing: 6 of 10

Model: GHE-14B

ROOF TO POST
MORTICE CONNECTION

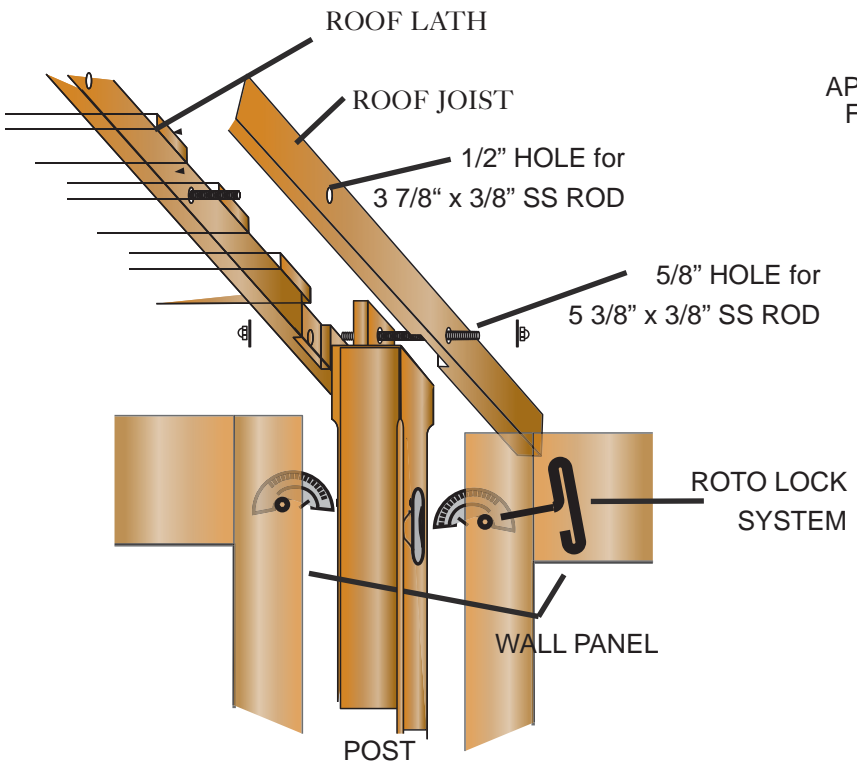

ROOF SYSTEM
RIDGED TRIANGULAR MODULES CONNECT TO FORM A
CONIC ROOF SYSTEM. THE COMPRESSION RING IS INTEGRAL
TO THE CONIC DESIGN AND ALLOWS RESULTANT FORCES
TO BE PERPENDICULAR TO GRADE.

ROOF
ATTACHMENT

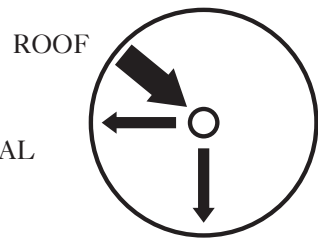
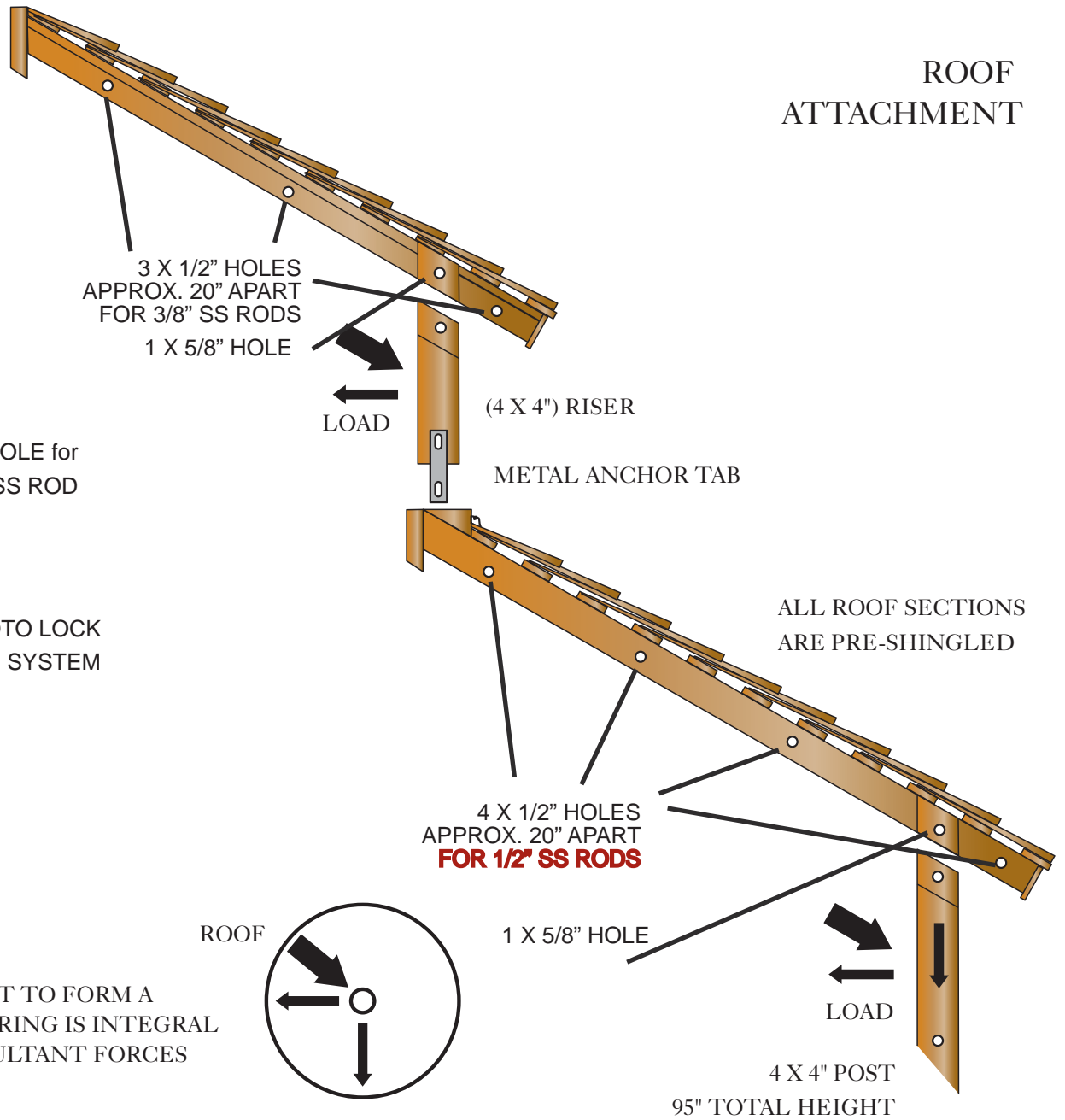

**VIXEN HILL CEDAR
PRODUCTS**
P.O.Box 389 - Elverson, PA 19520
800-423-2766

Created by: Andrea Beringer

Date: Jan 2015

Drawing : 7 of 10
Model: GHE-14B

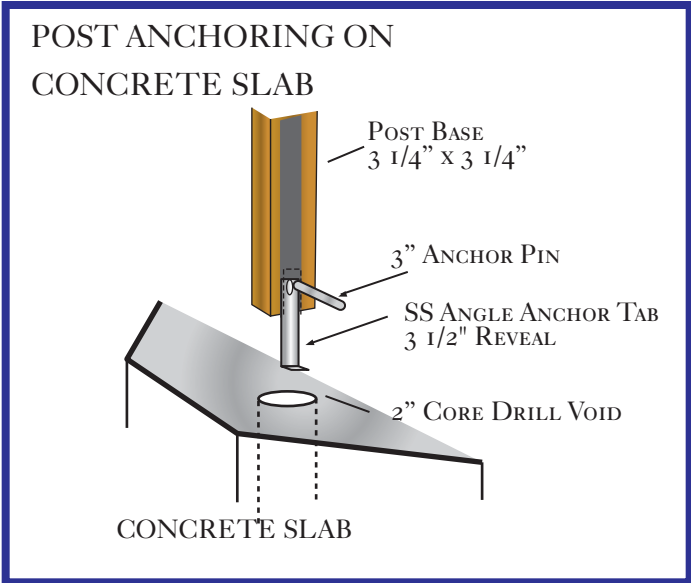
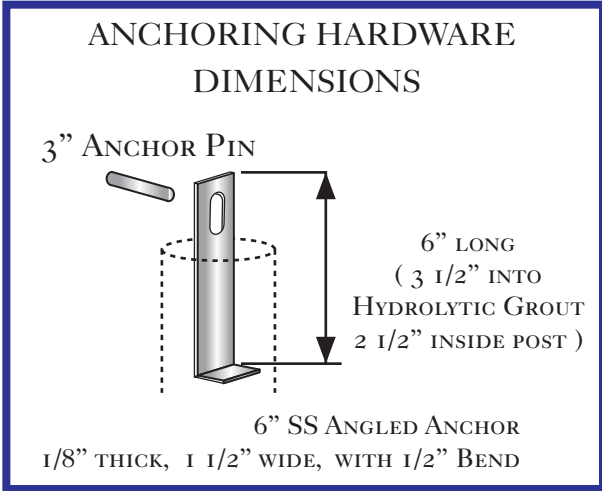
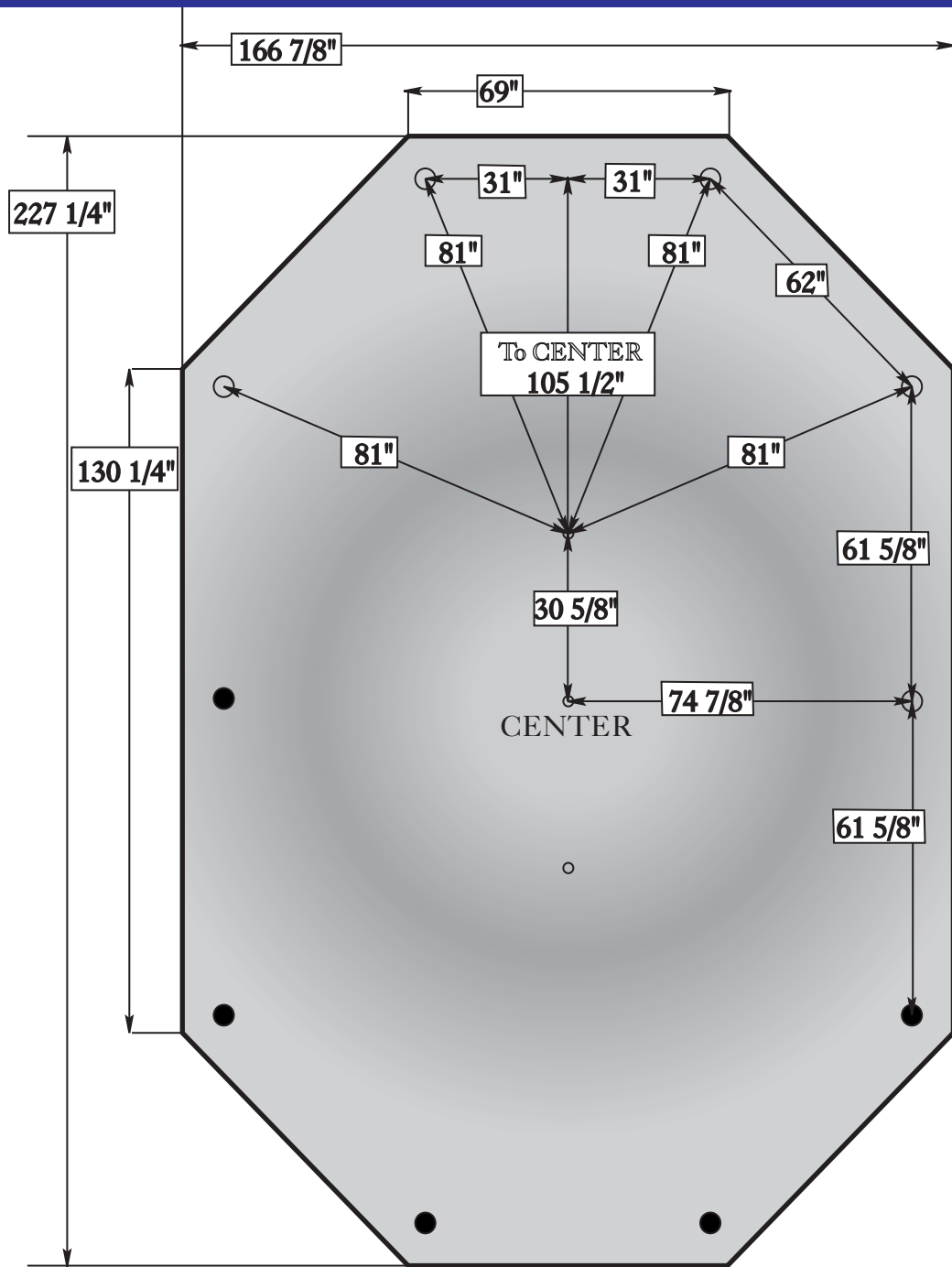

VIXEN HILL CEDAR PRODUCTS

P.O.Box 389 - Elverson, PA 19520
800-423-2766

Created by: Andrea Beringer

Date: Jan 2015

Drawing: 8 of 10

Model: 14' x 19'

Electrical

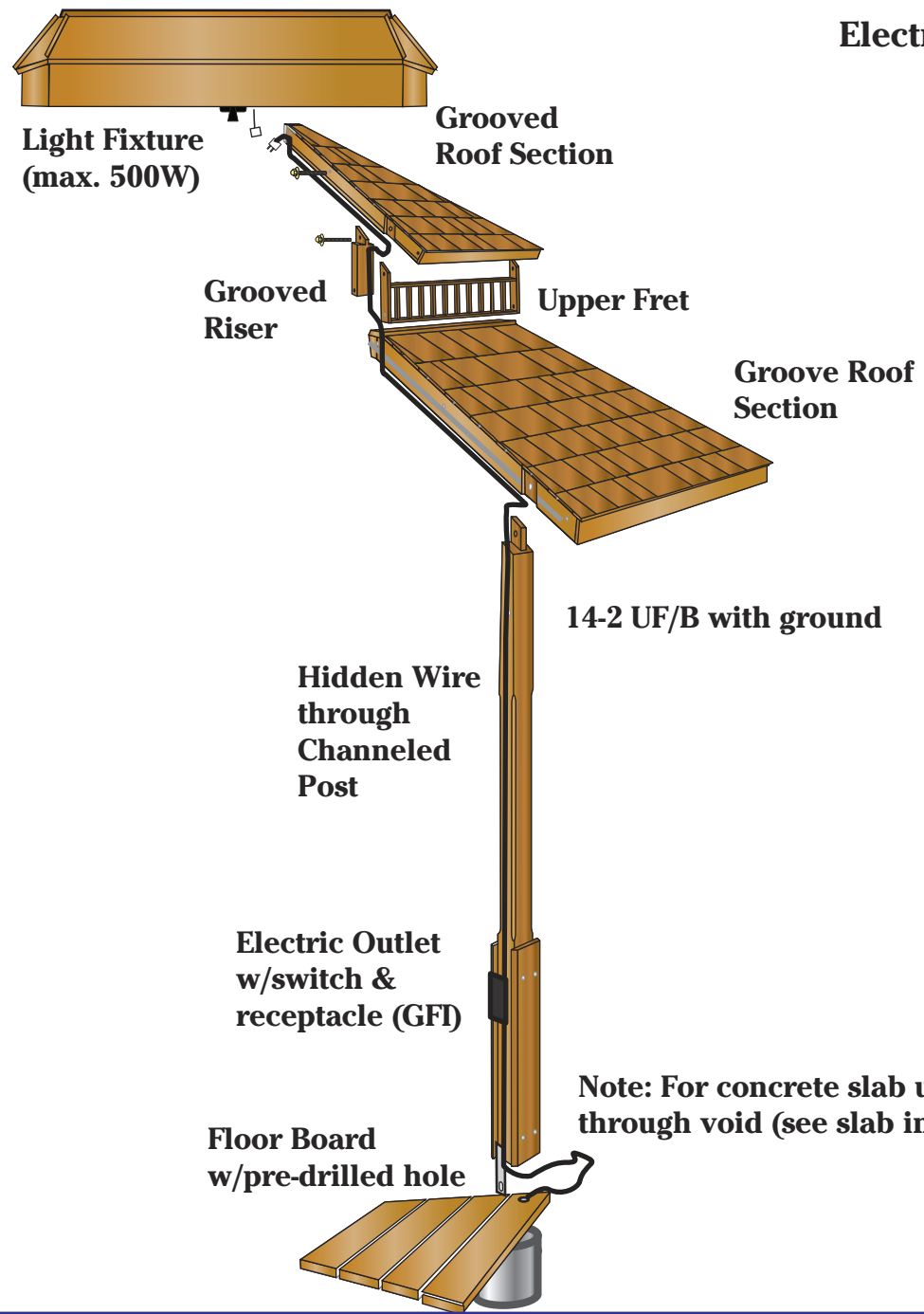

Additional Options:
Outlet posts (dual)
Fan Control post (fan/light)
Channel Posts (for custom wiring)

SPECIFICATIONS FOR THE CABINET MODELS (8X11'X 11X15' AND 14X19')

PART 1 GENERAL

1.1 SCOPE. THE CONTRACTOR SHALL FURNISH AND INSTALL A WOODEN GAZEBO AS SHOWN ON PLANS AND HEREIN SPECIFIED AS SUPPLIED BY VIXEN HILL MFG. CO. INC., OF ELVERSON, PA 19520.

PART 2 PRODUCT

2.1 WOOD MATERIALS. FOR CABINET GRADE SHALL BE FABRICATED FROM AIR-DRIED, #1 OLD GROWTH & ROT RESISTANT WESTERN RED CEDAR. ALL WOOD SHALL BE GRAIN SELECTED DURING IN-HOUSE MILLING FOR BEST APPLICATION AND SAFE USE.

2.2 ROOFING SYSTEM. SHINGLES SHALL BE OF OR EQUAL TO #1 PERFECTION CLEAR HEART CEDAR AND PER THE FOLLOWING SPECIFICATIONS 5X, 16" LONG, 1/2" THICK, TAPERED. ROOF LATH SHALL BE OF NO LESS THAN NET FINISHED SIZE 1X3" WITH A 5" SPACING. ROOF SECTIONS SHALL BE COMPLETELY PRE-ASSEMBLED AND PRE-CUT, AND JOINTS BETWEEN ROOF SECTIONS SHALL BE SELF-SEALING TO PRECLUDE CAPPING. CAULK IS RECOMMENDED TO BE USED AT THE ROOF JOIST.

2.3 SURFACE FINISH. ALL WOOD MEMBERS SHALL BE SURFACED FOUR SIDES. SURFACES DISPLAYING PLANER SKIPS OR SAW MARKS AFTER DRESSING SHALL BE LIMITED TO LESS THAN 25% OF SHOWN FACES. HAND CONTACT EDGES MAY BE ROUNDED, CHAMFERED, OR EDGE-SHAPED FREE OF SPLINTERS AND SMOOTH TO THE TOUCH. ALL EXPOSED SURFACES SHALL BE PREPARED FOR MAXIMUM ACCEPTANCE OF OIL-BASED FINISHES (OPTIONAL WITH ADDITIONAL COST).

2.4 HARDWARE. ALL ASSEMBLY & ANCHORING HARDWARE SHALL BE PROVIDED. CONCEALED ROTO-LOCKS ARE BUILT INTO THE WALL PANEL. THE THREADED RODS FOR THE PANEL CAPPING PIECES ARE OF GALVANIZED STEEL WITH STAINLESS STEEL CAP NUTS & WASHERS AND OF A FINISH TYPE TO CONCEAL ALL THREADS. ALL HARDWARE IN GROUND CONTACT SHALL BE OF STAINLESS STEEL FOR CABINET GRADE. NO NAILS SHALL BE REQUIRED OR PROVIDED. THE STRAP HINGES FOR THE DOOR(S) ARE MADE FROM ZINC-PLATED & POWDER-COATED STEEL WITH A FLAT AND SMOOTH FINISH.

2.5 ELECTRICAL. STANDARD FOR CABINET GRADE. THE PRE-WIRED POST PROVIDES 110V ELECTRICAL SERVICE THROUGH WIRE (14-2 UF/B WITH GROUND). THE POST HAS AN ELECTRICAL BOX WITH (GFI) RECEPTACLE AND LIGHT SWITCH. THE LIGHT FIXTURE IS SCREWED INSIDE THE CUPOLA FOR UP TO 500W STRENGTH. WIRES SHALL BE HIDDEN WITHIN THE COMPONENT PARTS THROUGH GROOVED ROOF SECTION AND CHanneled POST. ALL ELECTRICAL COMPONENTS SHALL BE UL APPROVED.

2.6 CONNECTIONS & ANCHORING. FACTORY MODULE CONSTRUCTION SHALL INCLUDE POCKET JOINTS AND STAINLESS STEEL THREADED FASTENERS. ON-SITE INTER-CONNECTION OF MODULES SHALL BE ACHIEVED USING THREADED RODS AND STAINLESS OR BRASS CAP NUTS AND WASHERS. ANCHORING SHALL BE CONCEALED AND APPROPRIATE TO THE SURFACE MOUNTING MATERIAL. ONLY SIMPLE HAND TOOLS SHALL BE REQUIRED FOR ASSEMBLY.

2.7 ENGINEERING. DESIGN OF CONNECTIONS AND MATERIALS USED SHALL BE SUCH AS TO ADHERE TO STRUCTURAL REQUIREMENTS OF MAJOR BUILDING CODES. DRAWINGS AND REPRESENTATIVE ENGINEERING SHALL BE AVAILABLE FROM THE MANUFACTURER FOR THE PURPOSE OF PERMITS OR ARCHITECTURAL REVIEW.

PART 3 EXECUTION

3.1 PREFABRICATION. ALL COMPONENT PARTS SHALL BE PRE-ASSEMBLED TO THE FULLEST EXTENT POSSIBLE, TO PRECLUDE ANY ON-SITE DRILLING, CUTTING, FILLING, NAILING OR SANDING. ALL PREFABRICATION FASTENERS SHALL BE HIDDEN FROM VIEW OR CHanneled AND STRIPPED WITH MATCHING WOOD WHERE VISIBLE.

3.2 INSTALLATION. THE GAZEBO KIT SHALL BE SUPPLIED WITH ALL NECESSARY HARDWARE, SHOP DRAWINGS AND COMPLETE INSTRUCTIONS TO PROVIDE FOR EFFICIENT ON-SITE ASSEMBLY. AVERAGE ASSEMBLY TIME ON A PREPARED FOUNDATION SHALL NOT EXCEED 15 MAN-HOURS.



**VIXEN HILL CEDAR
PRODUCTS**
P.O.Box 389 - Elverson, PA 19520
800-423-2766

Created by: Andrea Beringer

Date: Jan 2015

Drawing: 10 of 10

Model: GH